

LONGER

## BT100-1F PERISTALTIC PUMP OPERATING MANUAL

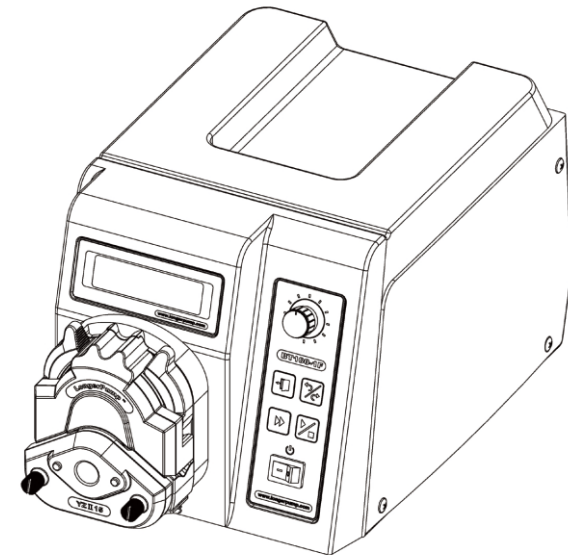

LONGER

**Baoding Longer Precision Pump Co., Ltd.**

Add: 3rd/4th Floor, Building 6B, University Science Park  
Baoding National, High - Tech Industrial Development Zone  
Baoding, Hebei, China 071051  
Tel: 86 - 312 - 3110087 3138553  
Fax: 86 - 312 - 3168553  
E - mail: longer@longerpump.com  
Http://www.longerpump.com

BT100-1F Peristaltic Pump

Baoding Longer Precision Pump Co.,Ltd.

 **IMPORTANT INFORMATION:**

Please read operation manual carefully before operation.

 **WARNINGS:**

- Tubing breakage may result in fluid being sprayed from pump. Use appropriate measures to protect operator and equipment. Please check the tubing frequently and change the tubing in time.
- If the power line or the plug is worn or damaged please pull out the plug (Hold the plug not the power line when pulling out).
- Please shut down the power supply and pull out the plug when meet below circumstances (Hold the plug not the power line when pulling out).  
The fluids splash on the body of the pump.  
You think the pump needs to be maintained or repaired.
- Please shut down the power supply before install the external control equipments.

**Table of Contents**

<b>Instruction</b> .....	1
<b>Operation Panel</b> .....	2
<b>Basic Operation</b> .....	2
<b>Running Interface</b> .....	3
Flow Rate Display .....	3
Dispensing Display .....	3
<b>Suitable Pump Head and Tubing</b> .....	4
<b>Pump Head Installation</b> .....	5
<b>Menu Diagram</b> .....	5
<b>System Setting</b> .....	6
Pump Head and Tubing Setting .....	6
External Control .....	6
Address .....	6
Footswitch Setting .....	7
Back Suction Time Setting .....	7
<b>Control Mode</b> .....	8
<b>Dispensing Setting</b> .....	8
Dispensing Volume .....	8
Copy No .....	8
Flow Rate .....	9
Pause Time .....	9
<b>Calibration</b> .....	9
Flow Rate Calibration .....	9
Dispensing Volume Calibration .....	10
<b>Operation Procedure</b> .....	11
Flow Rate Mode Operation Procedure .....	11
Dispensing Mode Operation Procedure .....	11
<b>External Control Input</b> .....	12
<b>External Control Output</b> .....	14
<b>Footswitch Function</b> .....	14
<b>Communication Function</b> .....	14
<b>Maintenance</b> .....	15
<b>Warranty</b> .....	15
<b>Technical Specification</b> .....	16

**Introduction**

Applicable pump heads for BT100-1F are YZ1515x, YZ2515x, YZ1115, YZ1125 and DG-1, DG-2, DG-4. The pump delivers flow rates from 0.2 µL to 500 mL / min and dispensing volume is from 0.01 mL to 9.99 L. Combining 128 × 32 LCD display with membrane keypad and rotary coded switch makes the operation easy and prompt. The speed can be adjusted manually or automatically through external control interface.

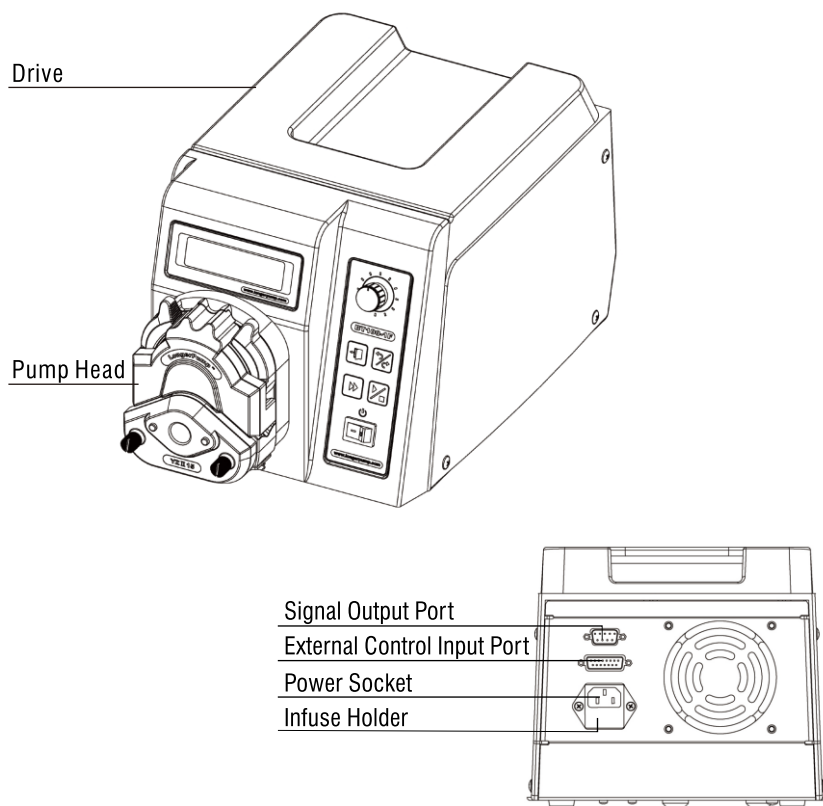

- Ref. page 11 to know detailed external control function.
- The pump must be grounded properly before operating in order to protect the operator in moist environment.

**Operation Panel**

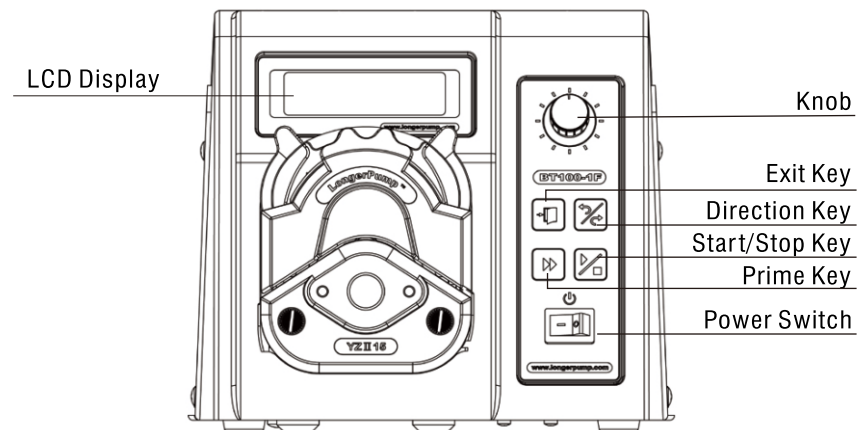

**Basic Operation**

- **Start/Stop Key**  
Press to start or stop the pump
- **Direction Key**  
Press to change the rotation direction of the pump
- **Knob**  
Function 1: Turn the **Knob** to adjust flow rate under none-prime working status.  
Function 2: Menu selection function, turn the **Knob** to select menu and set the parameters, press **Knob** to confirm the selection.
- **Prime Key**  
In common state, press the **Prime Key** to enter prime state when the pump runs at full speed for emptying, filling and rinsing operation; Press the **Prime Key** again to return to common state. In prime state, other keys are invalid.
- **Exit Key**  
Function 1: Cancel current operation and return to previous menu.  
Function 2: In dispensing working mode, press **Exit Key** to check current speed and the needed time for dispensing the set volume.
- **Power Switch**  
Turn on or off the pump.

**Running Interface**

Turn on the pump, the pump initializes itself first then display the running interface.

- Flow Rate Display

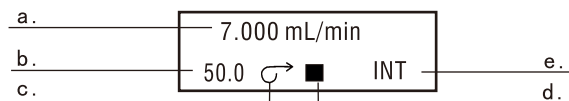



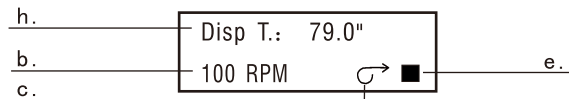
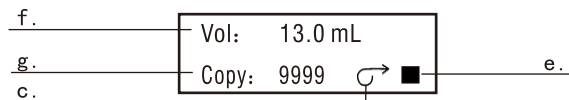

- Dispensing Display: Dispensing status is displayed by two interfaces below, these interface can be switched by pressing **Exit Key**.

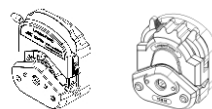
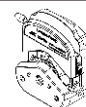

- a. Current flow rate: Display current flow rate. Turning the **Knob** can increase or decrease the flow rate.
- b. Current speed: Display current speed. Turning the **Knob** can increase or decrease the speed.
- c. Running direction: Indicate the direction of the pump.
- d. Running status: ► stands for pump running; ■ stands for pump stopping; || stands for pump pausing. Press **Start/Stop Key** to control the working state of the pump.
- e. Control Mode: **INT** stands for internal control mode; **Off** stands for closing the external control by setting menu; **V** stands for inserting analog voltage input control module into **External Control Port**; **mA** stands for inserting analog current control module into **External Control Port**; **Hz** stands for inserting 0-10 kHz frequency input module into **External Control Port**.
- f. Dispensing Volume: Display dispensing volume under dispensing mode.
- g. Copy number: Display copy number under dispensing mode.
- h. Dispensing time: Display the dispensing time. When the dispensing procedure starts, the dispensing time will count down. Adjust the Flow rate to change Dispensing time in dispensing parameters setting interface.

**Suitable Pump Heads and Tubing**

Suitable Pump Heads	Tubing (mm)	Ref. Flow Rate (mL/min)
 YZ1515x    YZ II 15	13#	7µL-7mL/min
	14#	0.027-27
	19#	0.051-51
	16#	0.082-82
	25#	0.17-170
	17#	0.29-290
	18#	0.38-380
 YZ2515x	15#	0.17-170
	24#	0.29-290
 YZ II 25	15#	0.17-170
	24#	0.29-290
	35#	0.38-380
	36#	0.50-500
 DG-1/2/4(10 Rollers)	0.13 × 0.91	0.2 µL/min-200 µL/min
	0.25 × 0.91	0.52 µL/min-520 µL/min
	0.51 × 0.91	2.0 µL/min-2.0mL/min
	1.02 × 0.86	4.6 µL/min-4.6mL/min
	1.65 × 0.86	0.014 - 14
	2 × 1	0.016 - 16
	2.4 × 0.8	0.022 - 22
	2.79 × 0.86	0.028 - 28
3.17 × 0.86	0.032 - 32	
 DG-1/2/4(6 Rollers)	0.13 × 0.91	0.25 µL/min-250 µL/min
	0.25 × 0.91	0.56 µL/min-560 µL/min
	0.51 × 0.91	2.2 µL/min-2.2mL/min
	1.02 × 0.86	5.8 µL/min-5.8mL/min
	1.65 × 0.86	0.018-18
	2 × 1	0.02-21
	2.4 × 0.8	0.026-26
	2.79 × 0.86	0.035-35
3.17 × 0.86	0.048-48	

Pump heads and tubing can be selected referring to above table. It is necessary to select suitable pump heads and tubing to get higher flow rate and higher dispensing accuracy. We suggest your needed flow rate range is in the range of 20% to 80% of ref. flow rate range.

**Pump Head Installation**

The pump head is mounted on drive before the pump leaves the factory. Follow below procedure for changing another pump head.

1. Loose the two M4 screws which connect the pump head and the drive. Dismantle the pump head slightly.
2. Insert the flat end of the pump head's shaft to the slot of drive's coupling. Make the location hole of the pump head match the location pin of the drive.
3. Insert the two mounting screws into the mounting holes of the pump head. Then tighten the mounting screws to connecting hole of drive. (For more information, please refer to pump head's operation manual)

 Turn off the power before changing the pump head.

**Menu Diagram**

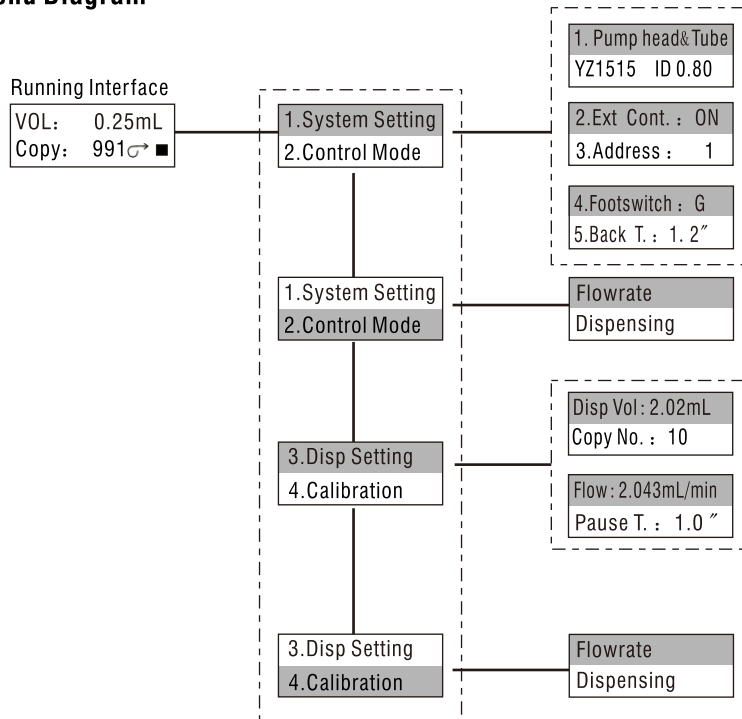

**System Setting:**

All the setting can not be done when pump is running.

- ❖ Pump head and tubing setting

Press the **Knob** to enter **System Setting** interface, press **Knob** again to enter submenu of **Pump Head & Tube**, then press **Knob** again the pump will show all the suitable pump head, turn **Knob** to select needed pump head, press the **Knob** again to confirm the selection of pump head and the pump will show all the suitable tubing, turn **Knob** to select needed tubing and press **Knob** to confirm or press **Exit Key** to return to previous menu.

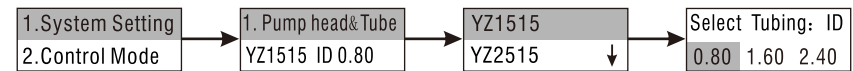

- ❖ External Control

- Set the pump to enable the **External Control** or not.

On: Enable **External Control**

Off: Disable **External Control**

- Set the **External Control**

Press and turn **Knob** to highlight the external control line. Press **Knob** to enter next interface, turn **Knob** to select **On** or **Off** then press **Knob** to confirm or press **Exit Key** to cancel the selection and return to previous menu.

In external control mode, the status of external control can be changed when the pump stops.

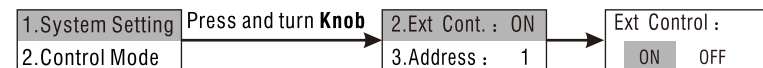

- ❖ Address:

- When control computer controls many pumps through RS485 interface, it must identify each pump's I. D. Every pump I.D. should be unique. It's the identification of Every pump. Maximum 30 pieces BT100-1F can be controlled through RS485 at the same time.

- Setting **Address** of each pump

Press and turn the **Knob** to highlight the **Address** line. Press **Knob** again to enter next interface, turn Knob to select **Pump ID**, and then press **Knob** to confirm or press Exit Key to cancel the selection and return to previous menu.

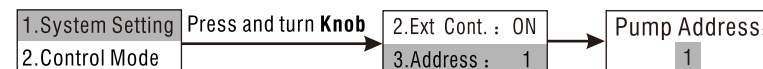

❖ Footswitch Setting

- Footswitch has two kinds of working status.

**Trigger:** Press footswitch, the pump starts running; Press footswitch again, the pump stops.

**Gated:** The pump runs as long as the footswitch is pressed.

- Set Footswitch

Press and turn **Knob** to highlight the Footswitch line. Press **Knob** to enter next interface. Turn **Knob** to select **Trigger** or **Gated**, then press **Knob** to confirm or press **Exit Key** to cancel the selection and return to previous menu.

💡 The pump identifies the Longer Footswitch automatically. When the pump connects the footswitch, the **Start/Stop** Key on operating panel is invalid no matter the remote control is on or off.



❖ Back Suction Time Setting

- In dispensing and filling state, to prevent the liquids from dropping to cause error when the filling stops, the pump will back-turn a suction angle to suck back the liquids. The back suction is the same for each filling operations, it doesn't influence the filling accuracy.

- Set **Back Suction Time:**

Press and turn **Knob** to highlight the back suction time line. Press the **Knob** to enter next interface, turn **Knob** to adjust **Back Suction Time**, press **Knob** to confirm or press **Exit Key** to cancel the adjustment and return to previous menu.



**Control Mode**

- The pump has two kinds of working mode: **Flowrate** and **Dispensing**.

- Set **Control Mode:**

Press and turn the **knob** to highlight control mode line. Press **Knob** to enter next interface, turn Knob to select control mode, press **Knob** to confirm or press **Exit Key** to cancel the selection and return to previous menu.

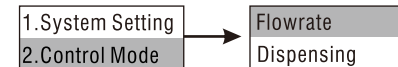

**Dispensing Setting**

Before dispensing process, the parameters including Pump Head, Tubing, Dispensing Volume, Copy number, Flow Rate and Pause time must be set.

- ❖ Dispensing Volume: the volume that the pump dispenses between every time interval.

- Press and turn **Knob** to highlight dispense setting line. Press **Knob** to highlight dispensing volume line. Press **Knob** again to highlight the value of the volume. Turn **Knob** to select Dispensing Volume. Press **Knob** to confirm or press **Exit Key** to cancel the selection and return to previous menu.

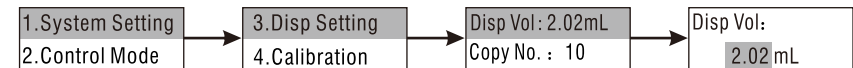

- ❖ Copy No.: the total filling number. Its range is form 0 to 9999.

- Press **Knob** to highlight copy number line. Press Knob to enter next interface. Turn **Knob** to select copy number. Press **Knob** to confirm or press **Exit Key** to cancel the selection and return to previous menu.

- If the **Copy No.** is "0", the dispensing process of the pump will continue until press **Start/Stop** key or turn off the pump to stop dispense process.

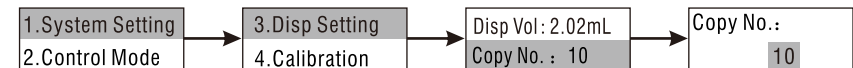

- ❖ Flow Rate: Adjusting the dispensing flow rate can change the dispensing time.
- Press and turn **Knob** to highlight dispensing flow rate line. Press **Knob** to enter next interface, turn **Knob** to select suitable flow rate. Press **Knob** to confirm or press **Exit Key** to cancel the selection and return to previous menu.

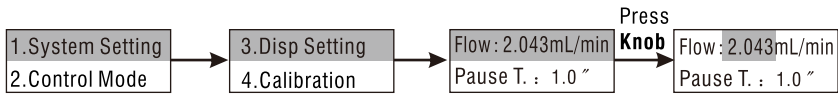

- ❖ Pause Time: Time Interval between every dispense process.
- Press and turn **Knob** to highlight pause time line. Press **Knob** to enter next interface. Turn **Knob** to select pause time. Press **Knob** to confirm or press **Exit Key** to cancel the selection and return to previous menu.

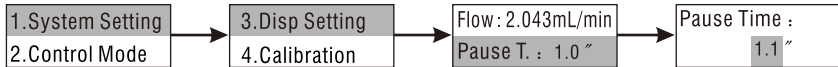

**Calibration**

Pump should be calibrated when flow rate or dispense volume is beyond the tolerance. Flow rate and dispensing volume can be calibrated separately in different application.

- ❖ Flow Rate Calibration
- Press and turn **Knob** to highlight calibration line. Press **Knob** to enter next interface. Turn **Knob** to select Flowrate. Press **Knob** to highlight test time line. Press **Knob** again to highlight the value of time. Turn **Knob** to select test time (its range is from 0.5 to 30 minutes). Press **Knob** to confirm or press **Exit Key** to cancel the selection and return to previous menu.
- Press Start/Stop Key, the LCD displays running time and actual volume. Running time counts down.
- Turn **Knob** to input actual tested volume. Press **Knob** to confirm. The calibration operation can be repeated.

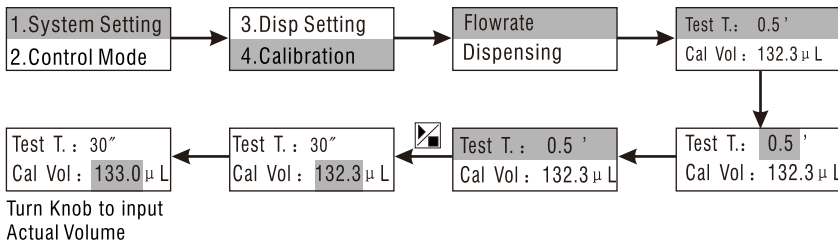

- If the actual volume is known in advance, enter the calibration interface and input the actual volume directly.

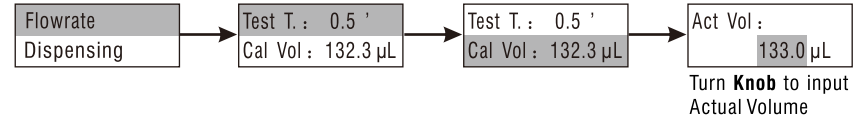

❖ Dispensing Volume Calibration

The parameters can not be changed under dispensing volume calibration operation. The defaulted parameters are the parameters set under Dispensing Setting.

- Pump stops under dispense mode, press and turn **Knob** to highlight calibration line. Press **Knob** to enter next interface. Turn **Knob** to select Dispensing. Press **Knob** to enter next interface.
- Press **Start/Stop Key**, the LCD displays running time and actual volume. Running time counts down.
- Turn **Knob** to input actual tested volume. Press **Knob** to confirm.

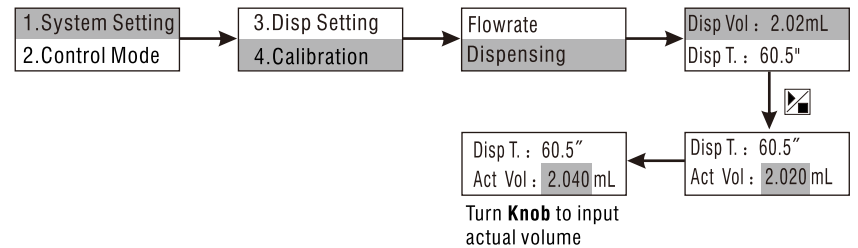

- If the actual volume is known in advance, enter the calibration interface and input the actual volume directly.

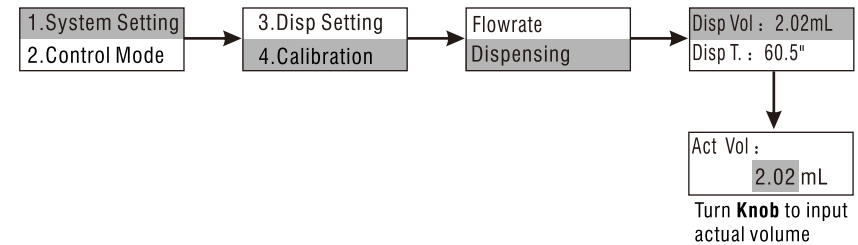

**Operation Procedure**

Select pump head and tubing refer to “Suitable Pump head, Tubing, Ref. Flow Rate” table before working. Thick wall tubing is preferred for longer service life.

❖ Flow rate mode operation procedure

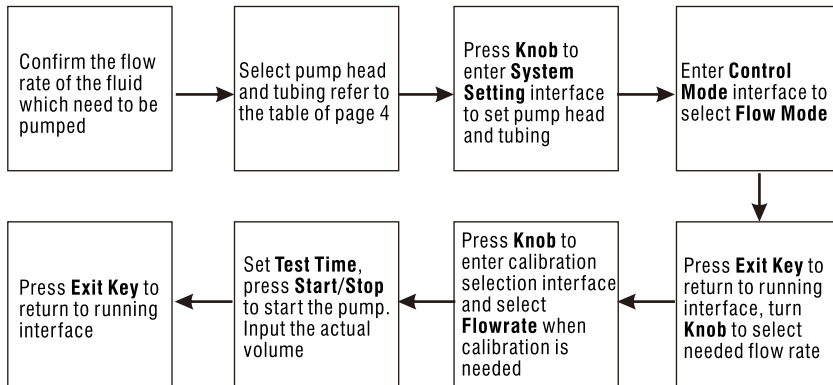

❖ Dispensing Mode operation procedure

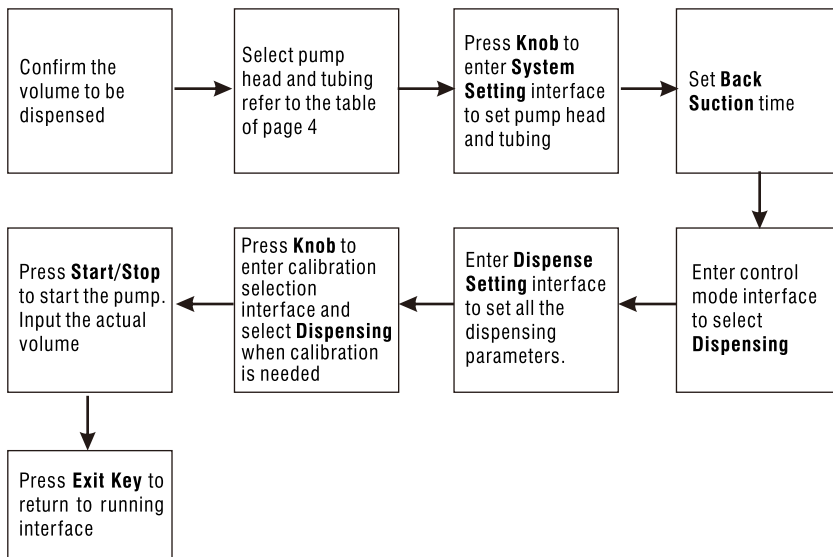

**External Control Input**

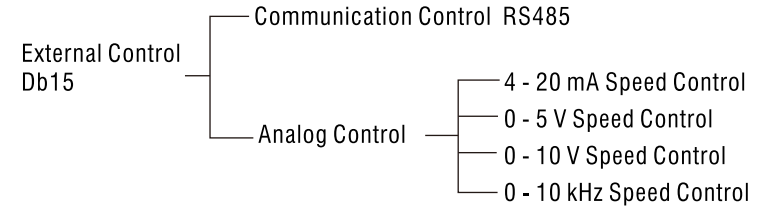

❖ Communication Control

The pump can connect to control computer (computer, PLC, SCM) through RS485 serial communication module (shown as below). Please contact Longer Company for communication protocol.

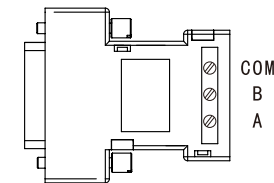

❖ Analog Signal Input function

Set the “External Control” in “on” state. External Control Module is shown as below.

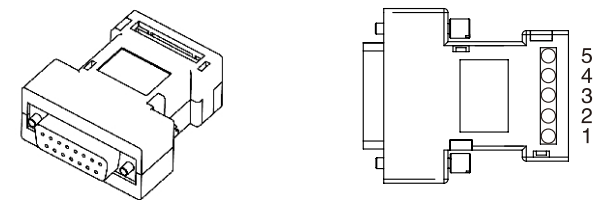

External Control Module

💡 Five kinds of standard external control module need to be ordered separately according to special requirements.



• **Terminals Definition**

- Terminal 1 Analog input in 4 - 20 mA, 0 - 5 V, 0 - 10 V external control module to control the speed of pump.
- Terminal 2 External control start/stop input. When connected to com, the pump runs, When connected to high level(5V TTL), the pump stop.
- Terminal 3 External control direction input. When connected to com, the pump rotates CW, When connected to high level, the pump rotaes CCW.
- Terminal 4 COM of external control input, for 4-20mA, 0-5V, 0-10V external control module.
- Terminal 5 COM of start/stop and direction.

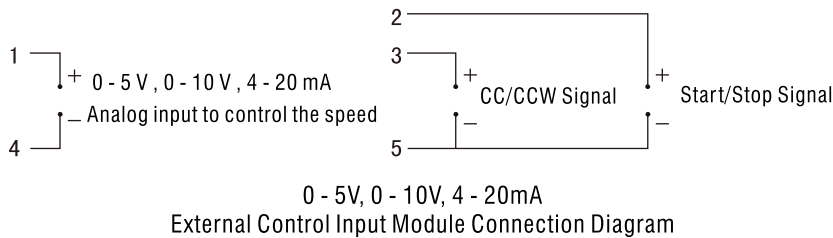

❖ **Pulse Signal Input Function:**

- Terminal 1 COM of external control input
- Terminal 2 External control start/stop input. Open, the pump runs; Close, the pump stops.
- Terminal 3 External control direction input. Open, the pump runs clockwise; Close, the pumps runs counter clockwise.
- Terminal 4 Pulse input in 0 - 10 kHz pulse external control module to control the speed of the pump.
- Terminal 5 COM of pulse input

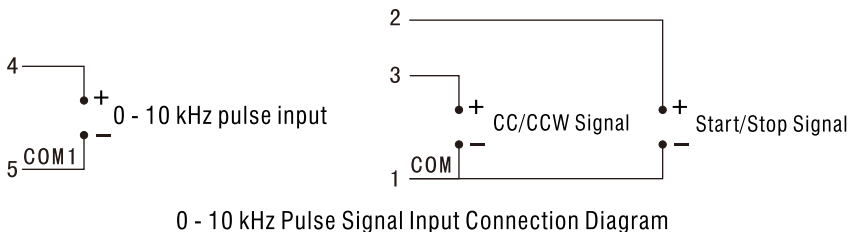

**External Control Output**

Pump is equipped with output port in order to monitor the status of pump. It adopts DB9 male socket as output port (see as below). External control output start/stop output, CW/CCW output and pulse output ( 0 - 100 rpm corresponding to 0 - 10 kHz). Output signal adopts optoelectronic isolation circuit. A pull-up resistor and power supply must be added when using.

• **Terminals Definition**

- Terminal 1 Start/Stop output. Pump outputs low level when it runs; pump output high level when it stops.
- Terminal 2 CW/CCW output. Pump output low level when it runs clock wise; pump output high level when it runs count clock wise.
- Terminal 8 Pulse output, 0 - 100 rpm corresponding to 0 - 10 kHz.
- Terminal 4, 6, 7 COM

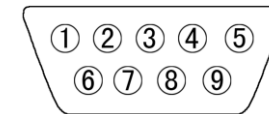

External Control Output Port Terminal Drawing: DB9

**Footswitch**

Control the start/stop of the pump through the external control interface.

💡 Footswitch is optional accessory; suitable type is JK-3.

**Communication Function**

BT100-1F can connect to the control computer (computer, PLC, SCM) through RS485 serial communication interface. Max. 30 pumps can be controlled by a control computer.

- 💡 1. The pump ID which connects to the control computer through RS485 serial communication interface must be unique to prevent the communication error.
- 2. Please contact Longer Company for communication protocol.

**Maintenance**

- When the pump is idle, we recommend you to release the tubing from pressure. This helps to protect the tubing from unnecessary strain and prolongs its service life
- Keep rollers clean and dry. This will prolong the service lives of tubing and pump head.
- The surface of drive and the pump head are not organic solvent and aggressive liquids resistant. Please pay attention when using.

 If a trouble happens, please contact us or our dealers.

**Warranty**

The warranty period for this product is one year. If repair or adjustment is necessary within the warranty period, the problem will be corrected at no charge if it is not due to misuse or abuse on your part, as determined by the manufacturer. Repair costs outside the warranty period, or those resulting from product misuse or abuse, may be invoiced to you.

**Technical Specifications**

❖ Functions

Acceptable Pump Head	YZ1515X, YZ2515X, YZII15, YZII25, DG-1, DG-2, DG-4
Operation Mode	Membrane keypad and Knob
Direction Control	CW and CCW, reversible
Prime	Full speed for fast filling and emptying
Back Suction	Preventing drippage of the liquid
Display	128×32 graphic LCD displays all the information
External Control Input	Control Start/Stop, direction and flow rate of the pump under Flowrate mode
Footswitch	Control Start/Stop of the pump
External Control Output	Output the signals of Start/Stop, direction and speed
Communication	Communicate with control computer
Flowrate Function	Deliver fluid at set flow rate
Dispensing Function	Set dispensing volume, copy number and pause time
Memory Function	Store all the running information automatically
Calibration	Acquire higher accuracy
Cooling Mode	Heat-emitting fan

❖ Specification

Flow Rates	0.2 μL /min to 500 mL/min
Dispensing Volume	0.01mL to 9.99L
Copy Number	0 to 9999
Pause Time	0.1s to 99.9min
Back Suction Time	0 to 99.9s
External Control Input	Start/Stop control, direction control, flow rates control (0 - 5V , 0 - 10V , 4 - 20 mA , 0 - 10kHz optional )
External Control Output	Start/Stop, Direction, 0 - 10 kHz speed signal, OC Gate output
Communication Interface	RS485
Applicable Power	AC 90 - 264V 50Hz/60Hz
Power Consumption	< 40W
Operating Condition	Temperature 0 to 40 °C Relative humidity < 80%
Dimension	(L×W×H) 285×207×180 (mm)
Weight	3.8 kg
IP Rating	IP 31